

Beacons and indicator banks Ø 70 “optimum” **Harmony XVE**

Catalogue
March

04



Beacons and indicator banks

Ø 70 mm Optimum, Harmony type XVE

- **Presentation** page 2
- **Description** page 3
- **Characteristics** page 4
- **References** pages 5 to 7
- **Dimensions, mounting,
connection** pages 8 and 9

Presentation

The beacons and indicator banks of the XVE range are designed for remote signalling of the status of a machine, equipment or specific application, either visually using illuminated units which are visible throughout 360° or audibly using an 85 dB buzzer. The XVE Optimum range provides efficient signalling (5 colours available), at medium range distances (30 m), in both indoor and outdoor environments. The standard configuration of the beacons and indicator banks is an IP 42 degree of protection, which is sufficient for the majority of indoor applications. Both the IP 42 pre-configured beacons and indicator banks can be upgraded to IP 54 by using a sealing kit (1). Depending on the indicator bank base unit selected, it is possible to achieve an IP 54 degree of protection for outdoor usage (1).

Composition

- The beacons are supplied complete and incorporate a single steady or “flash” light illuminated unit and a short fixing base. They are ready to use.
- The indicator banks must be assembled by the user and comprise signalling units, mounted on a base unit, and a fixing base. These various items are to be selected from the catalogue.
- For an indicator bank a maximum of 5 illuminated units or 4 illuminated units + 1 audible unit can be assembled.
- The illuminated or audible units stack vertically and are easily fitted together. A screw secures their mounting. Electrical connections between each unit are made automatically as the units are mechanically assembled.
- All the signalling units are identical in size and their positioning is unrestricted.

Signalling functions

Steady light signalling

Two types of light source are available for steady light signalling:

- The incandescent BA 15d base fitting bulb, 5 W max. power, is recommended for infrequent usage and where no vibration or mechanical shock exists. The bulb is not included with the lens unit and must be fitted separately.
- LEDs are recommended for continuous usage: 100,000 operating hours without maintenance and low consumption. They have a good resistance to vibration. Using an LED of a colour best suited to the colour of the lens unit provides optimal luminosity.

Flashing light signalling

Flashing light signalling is also obtained using the LED. It meets requirements regarding reliability, continuous usage and electronic simplicity. A flashing function can also be obtained from a steady light LED illuminated unit by using a PLC output signal.

“Flash” light signalling

The light source is a 1 Joule discharge tube which delivers a powerful warning signal. It is available for the 5 colours.

Audible signalling

Audible signalling is provided by a continuous tone buzzer with a power rating of 85 dB at 1 m.

Installation

Mounting

Fixed onto support panel using plastic monobloc fixing base or fixing base comprising an aluminium support tube pre-fitted into a plastic fixing support.

Cabling

Cabling by means of terminal block incorporated in base unit. The terminals are protected and of the screw and captive cable clamp type.

(1) See page 7.

Beacons and indicator banks

Ø 70 mm Optimum, Harmony type XVE

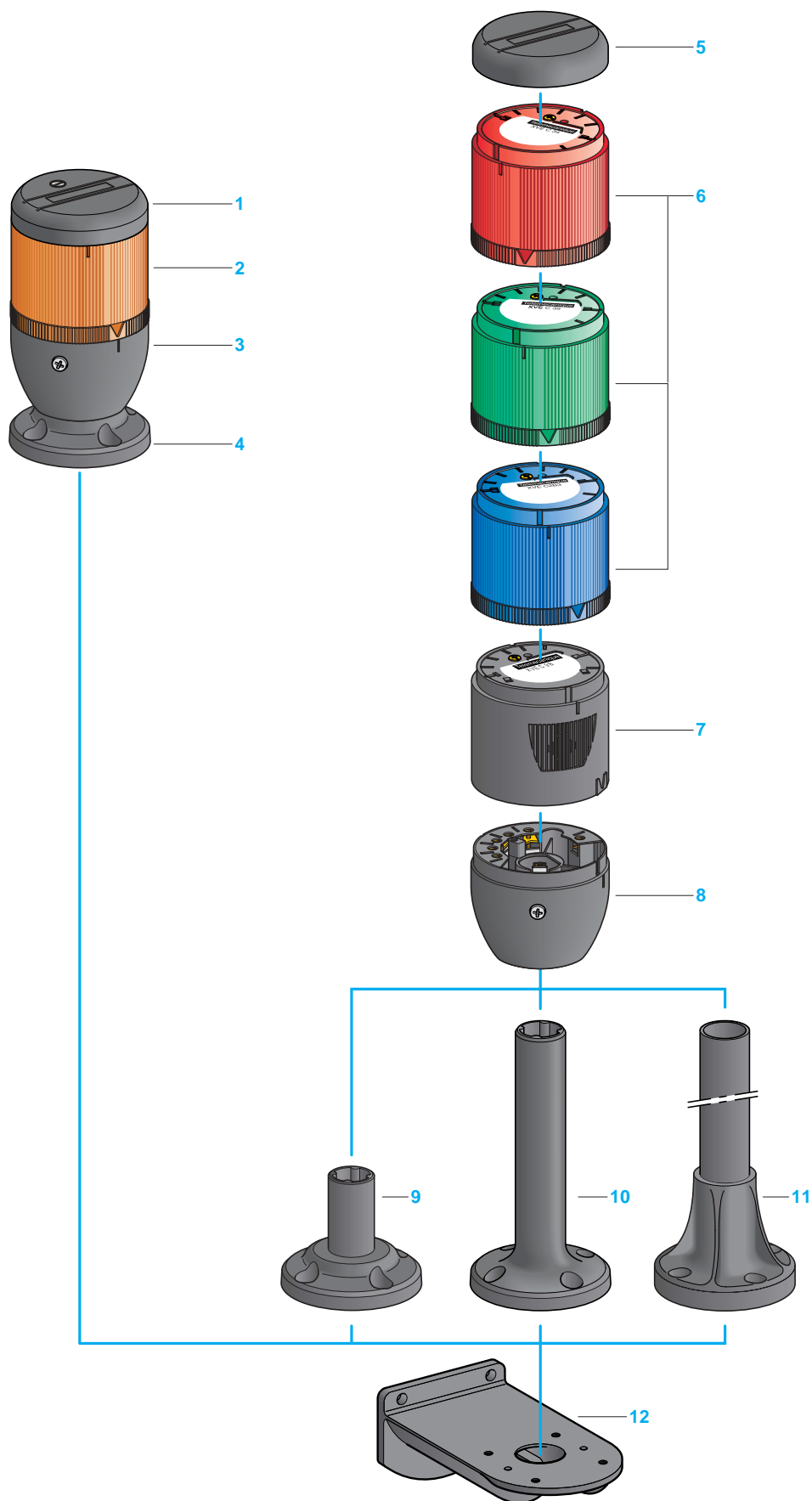

Description

Illuminated beacon

The illuminated beacon is a complete product comprising:

- 1 A screw fixing cover.
- 2 One coloured illuminated unit (green, red, orange, blue or clear).
- 3 A base unit with terminal block and bottom cable entry.
- 4 A monobloc fixing base for mounting on machine.

Indicator bank

The indicator bank is a customer assembled product using:

- 5 A cover.
- 6 1 to 5 coloured illuminated units (green, red, orange, blue or clear) with a choice of 3 types of signalling (steady, flashing or "flash").
- 7 1 audible unit.
- 8 A base unit (IP 42 or IP 54) with terminal block and bottom cable entry.
- 9 A plastic fixing base, 20 mm high.
- 10 A plastic fixing base, 100 mm high.
- 11 An aluminium support tube, black or natural finish, length: 100, 400 or 800 mm, pre-fitted and glued into a fixing base.

To be ordered separately:

- 12 Fixing plate for mounting on vertical support.

Environment						
Degree of protection	Conforming to IEC 60529		<ul style="list-style-type: none"> ■ IP 42 in vertical position, IP 40 for other positions ■ IP 54 for reinforced protection version: □ for all mounting positions using fixing base XVE Z13, □ only in vertical position for other heights of fixing base 			
Product certifications			CE, UL, CSA			
Approvals			CCC (pending)			
Conformity to standards			IEC/EN 60947-1, IEC/EN 60947-5-1			
Ambient air temperature	For storage	°C	- 40...+ 70			
	For operation	°C	- 25...+ 55			
Electric shock protection Conforming to IEC 61140	Mounted on plastic support tube		Class I			
	Mounted on aluminium support tube		Class I			
Protective treatment			Standard version: "TC"			
Electronic components protection (LED and flash)	By integral fuse in series on the common	A	0.63 (\approx 24 V)			
		A	0.16 (\approx 120...240 V)			
Electrical characteristics						
Illuminated units			With bulb, not included (lens unit only)	With integral LED, steady light	With integral LED, flashing light	With "flash" discharge tube, 1 Joule
Rated insulation voltage (Ui)	Conforming to IEC 60947-1	V	250	250	250	250
Voltage limits	Conforming to IEC 60947-5-1	V	0.85...1.10 Un (Un: nominal voltage)			
Light source			BA 15d base fitting bulb, maximum power 5 W (240 V max.)	LED	LED	"Flash" discharge tube, 1 Joule
Consumption	On \approx 24 V	mA	Depending on bulb used	18	20	135 on \sim 24 V 76 on \approx 24 V
	On \approx 120 V	mA	Depending on bulb used	23	23	27
	On \sim 230/240 V	mA	Depending on bulb used	20	20	18
Rated impulse withstand voltage	Conforming to IEC 60947-1	kV	U imp = 4			
Illuminating power	Average value for all colours	cds/m²	640	800	800	–
Flashing frequency	Nominal value	Hz	–	–	1	1
Audible units						
Consumption	On \approx 24 V	mA	13			
	On \approx 120 V	mA	20			
	On \sim 230/240 V	mA	20			
Power	Continuous tone	dB	85 at 1 m			
	Fundamental frequency	kHz	2.8 for continuous tone			
Connection of illuminated and audible units						
Terminal referencing			1 terminal referenced "C" common to all 5 units 5 terminals referenced 1 to 5			
Connection	Maximum clamping capacity on protected, ready-to-tighten, screw and captive cable clamp terminals	mm²	1 x 1.5 with cable end			

Beacons and indicator banks

Ø 70 mm Optimum, Harmony type XVE Illuminated beacons



XVE L3



XVE L2



XVE L6



XVE Z083



XVB C12



DL1 BE/S

Illuminated beacons with steady light

Description	Light source	Supply voltage	Colour of lens unit	Reference	Weight kg
Complete unit comprising: - 1 screw fixing cover, 5 W max. - 1 illuminated unit, - 1 base unit, - 1 short fixing base	Bulb, not included, 5 W max.	≈ 240 V max.	Green	XVE L33	0.245
			Red	XVE L34	0.245
			Orange	XVE L35	0.245
			Blue	XVE L36	0.245
			Clear	XVE L37	0.245
Illuminated unit with integral LED		≈ 24 V	Green	XVE L2B3	0.250
			Red	XVE L2B4	0.250
			Orange	XVE L2B5	0.250
			Blue	XVE L2B6	0.250
			Clear	XVE L2B7	0.250
		~ 120 V	Green	XVE L2G3	0.250
			Red	XVE L2G4	0.250
			Orange	XVE L2G5	0.250
			Blue	XVE L2G6	0.250
			Clear	XVE L2G7	0.250
		~ 230 V/240 V	Green	XVE L2M3	0.250
			Red	XVE L2M4	0.250
			Orange	XVE L2M5	0.250
			Blue	XVE L2M6	0.250
			Clear	XVE L2M7	0.250

Illuminated beacons with "flash" light

Description	Light source	Supply voltage	Colour of lens unit	Reference	Weight kg
Complete unit comprising: - 1 screw fixing cover, 1 Joule "flash" - 1 illuminated unit, discharge tube - 1 base unit, - 1 short fixing base	Illuminated unit with 1 Joule "flash" discharge tube	≈ 24 V	Green	XVE L6B3	0.270
			Red	XVE L6B4	0.270
			Orange	XVE L6B5	0.270
			Blue	XVE L6B6	0.270
			Clear	XVE L6B7	0.270
		~ 120 V	Green	XVE L6G3	0.270
			Red	XVE L6G4	0.270
			Orange	XVE L6G5	0.270
			Blue	XVE L6G6	0.270
			Clear	XVE L6G7	0.270
		~ 230 V/240 V	Green	XVE L6M3	0.270
			Red	XVE L6M4	0.270
			Orange	XVE L6M5	0.270
			Blue	XVE L6M6	0.270
			Clear	XVE L6M7	0.270

Separate components

Description	Details	Reference	Weight kg
IP 54 sealing kit	1 lens unit seal + 1 base unit seal + 2 fixing base seals	XVE Z083	0.005
Fixing plate	For mounting beacons on vertical support (requires a fixing base)	XVB C12	0.380

Description	Electrical characteristics	Sold in lots of	Reference	Weight kg
Clear incandescent bulbs with BA 15d base fitting for lens units type XVE L3	5 W ≈ 24 V	10	DL1 BEBS	0.100
	5 W ≈ 120 V	10	DL1 BEGS	0.100
	5 W ≈ 230 V	10	DL1 BEMS	0.100

Beacons and indicator banks

Ø 70 mm Optimum, Harmony type XVE

Indicator banks for customer assembly

Composition of an indicator bank:



- 1 Cover and base unit
- + 2 Illuminated or audible units (5 units max.)
- + 3 Fixing base



Illuminated units with steady light

Description	Light source	Supply voltage	Colour of lens	Reference	Weight kg	
Lens units only for BA 15d base fitting bulb	Bulb, not included, 5 W max.	≈ 240 V max.	Green	XVE C33	0.072	
			Red	XVE C34	0.072	
			Orange	XVE C35	0.072	
			Blue	XVE C36	0.072	
			Clear	XVE C37	0.072	
Illuminated units	Integral LED	≈ 24 V	Green	XVE C2B3	0.077	
			Red	XVE C2B4	0.077	
			Orange	XVE C2B5	0.077	
			Blue	XVE C2B6	0.077	
			Clear	XVE C2B7	0.077	
			~ 120 V	Green	XVE C2G3	0.077
				Red	XVE C2G4	0.077
		Orange		XVE C2G5	0.077	
		Blue		XVE C2G6	0.077	
		Clear		XVE C2G7	0.077	
		~ 230 V/240 V		Green	XVE C2M3	0.077
				Red	XVE C2M4	0.077
			Orange	XVE C2M5	0.077	
			Blue	XVE C2M6	0.077	
Clear	XVE C2M7		0.077			

Illuminated units with flashing light

Illuminated units	Integral LED	≈ 24 V	Green	XVE C5B3	0.077	
			Red	XVE C5B4	0.077	
			Orange	XVE C5B5	0.077	
			Blue	XVE C5B6	0.077	
			Clear	XVE C5B7	0.077	
			~ 120 V	Green	XVE C5G3	0.077
				Red	XVE C5G4	0.077
		Orange		XVE C5G5	0.077	
		Blue		XVE C5G6	0.077	
		Clear		XVE C5G7	0.077	
		~ 230 V/240 V		Green	XVE C5M3	0.077
				Red	XVE C5M4	0.077
			Orange	XVE C5M5	0.077	
			Blue	XVE C5M6	0.077	
Clear	XVE C5M7		0.077			

Illuminated units with “flash” light

Illuminated units	“Flash” discharge tube, 1 Joule	≈ 24 V	Green	XVE C6B3	0.094	
			Red	XVE C6B4	0.094	
			Orange	XVE C6B5	0.094	
			Blue	XVE C6B6	0.094	
			Clear	XVE C6B7	0.094	
			~ 120 V	Green	XVE C6G3	0.094
				Red	XVE C6G4	0.094
		Orange		XVE C6G5	0.094	
		Blue		XVE C6G6	0.094	
		Clear		XVE C6G7	0.094	
		~ 230 V/240 V		Green	XVE C6M3	0.094
				Red	XVE C6M4	0.094
			Orange	XVE C6M5	0.094	
			Blue	XVE C6M6	0.094	
Clear	XVE C6M7		0.094			

Audible units

Description	Power	Supply voltage	Reference	Weight kg
“Buzzer” single tone	85 dB at 1 metre	≈ 24 V	XVE C9B	0.090
		~ 120 V	XVE C9G	0.090
		~ 230 V/240 V	XVE C9M	0.090

Beacons and indicator banks

Ø 70 mm Optimum, Harmony type XVE

Indicator banks for customer assembly



XVE C21



XVB C21P



XVE Z13 XVD C02



XVB Z02 XVB Z03



XVB Z01



XVB C12



XVE Z081



XVE Z082



DL1 BEoS

Base units and covers

Indicator bank usage	Composition	Reference	Weight kg
Indoors (IP 42)	Base unit and cover	XVE C21	0.110
Outdoors (IP 54)	Base unit with seal + screw fixing cover + kit comprising 5 seals for lens units and buzzer + 1 seal for fixing base XVE Z13	XVE C21P	0.120

Fixing components

Description	Height under base unit (mm)	Colour	Reference	Weight kg
Plastic fixing bases	20	Black	XVE Z13	0.040
	100	Black	XVD C02	0.056
Fixing bases comprising: Ø 25 mm aluminium support tube + black plastic fixing support	80	Black aluminium	XVB Z02	0.110
		Aluminium	XVB Z02A	0.110
	400	Black aluminium	XVB Z03	0.200
		Aluminium	XVB Z03A	0.200
	800	Black aluminium	XVB Z04	0.325
		Aluminium	XVB Z04A	0.325

Description	For	Material	Reference	Weight kg
Fixing base	Ø 25 mm aluminium support tube	Plastic	XVB Z01	0.050

Description	For	Material	Reference	Weight kg
Fixing plate	Mounting indicator banks on vertical support (requires a fixing base)	Zamak	XVB C12	0.380

Separate components

Description	Composition	Reference	Weight kg
Cover	–	XVE Z081	0.010

Description	Electrical characteristics	Sold in lots of	Reference	Weight kg
IP 54 sealing kit	5 W toric seals for lens units + base unit seal + 1 fixing base seal + 1 seal for fixing base XVE Z13 + screw fixing cover		XVE Z082	0.015

Description	Electrical characteristics	Sold in lots of	Reference	Weight kg
Clear incandescent bulbs with BA 15d base fitting for lens units type XVE C3●	5 W ≈ 24 V	10	DL1 BEBS	0.100
	5 W ≈ 120 V	10	DL1 BEGS	0.100
	5 W ≈ 230 V	10	DL1 BEMS	0.100

Illuminated beacons XVE L●●●

Panel cut-out for mounting directly on fixing base

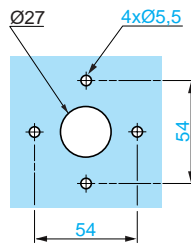
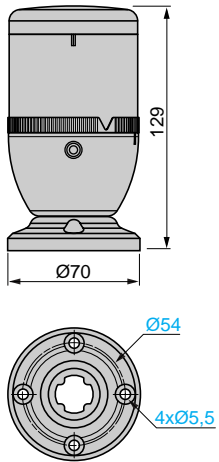

Mounting on fixing plate XVB C12

Vertical support panel drillings for mounting fixing plate XVB C12

Wiring scheme

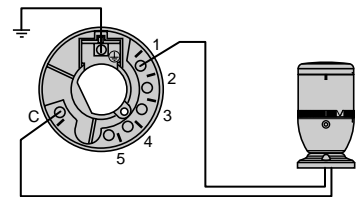
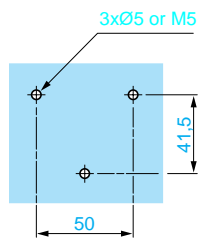
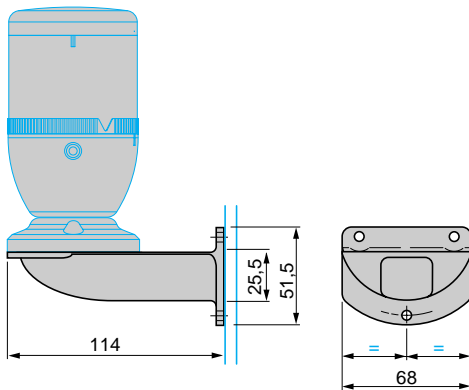

Indicator banks XVE C●●●

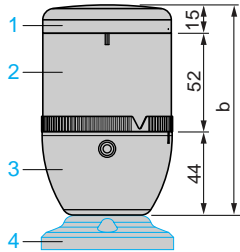

- 1 Cover XVE Z081 or cover XVE C21/C21P (with base unit),
- 2 Illuminated units XVE C●● and/or audible unit XVE C9●,
- 3 Base unit XVE C21/C21P,
- 4 Fixing bases (see below).

Height of indicator bank	
Number of units (ref. 2)	b
1 unit	111
2 units	163
3 units	215
4 units	267
5 units	319

Fixing bases (height under base unit)

XVE Z13

XVD C02

XVB Z0●●

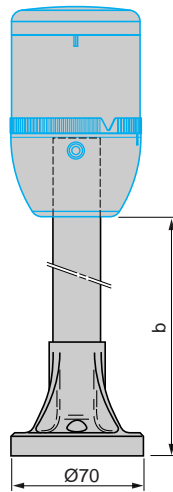
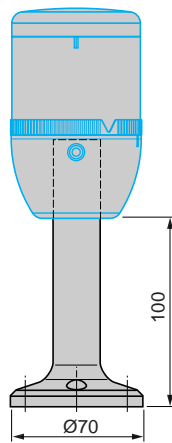
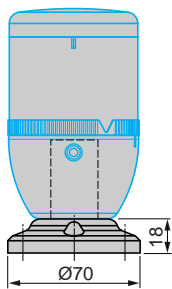

Panel cut-out for mounting directly on fixing base

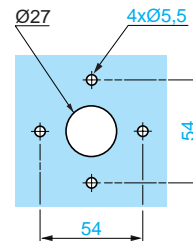

Height under base unit

Fixing base	b
XVB Z02/Z02A	80
XVB Z03/Z03A	400
XVB Z04/Z04A	800

Mounting on fixing plate XVB C12

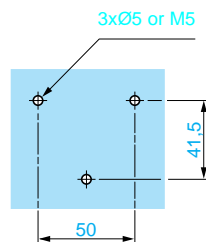
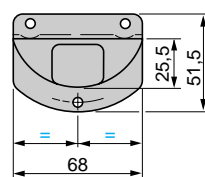
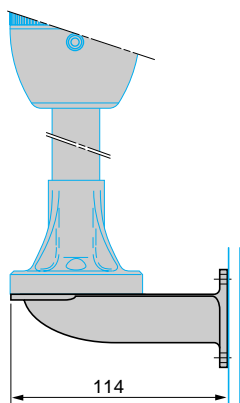

Vertical support panel drillings for mounting fixing plate XVB C12

Wiring scheme

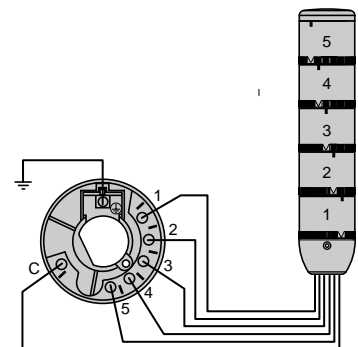

Schneider Electric Industries SAS

Headquarters

89, bd Franklin Roosevelt
F - 92506 Rueil Malmaison Cedex

<http://www.schneider-electric.com>

Owing to changes in standards and equipment, the characteristics given in the text and images in this document are not binding until they have been confirmed with us.

Production : Schneider Electric Industries
Photos : Schneider Electric Industries
Printed by :

